

Cirprotec

PSC / PSM

Type 1+2 and Type 2 surge protection



Pluggable protectors for transient overvoltage protection

Specialists in lightning and surge protection

Cirprotec (CPT) is a pioneer in the design and manufacture of surge and lightning protection devices. CPT has an extensive network of sales offices and is present in over 60 countries.

Comprehensive solution: protection, control and safety

CPT offers a wide range of specific products to provide a solution for any type of need in the field of lightning and surge protection.

- Internal protection (surge protectors)
- External protection (ESE lightning rods and Faradisation)
- Grounding system and insulation monitoring

Design, technical consulting and training services

Innovation and energy efficiency

Cirprotec is synonymous with innovation: a highly specialised team, test laboratories, high investment in R&D&i, international patents and presence on standards committees.

More efficient solutions to increase device lifetime and avoid excess current consumption.



Quality assurance

Cirprotec has a number of design, manufacturing and production centres and laboratories. All products are designed and manufactured entirely in Europe in accordance with international standards such as UNE, IEC, EN, NFC, VDE, UL, IEEE, under the control of ISO 9001 quality assurance.

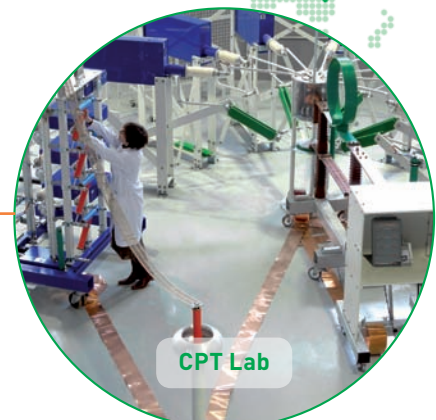
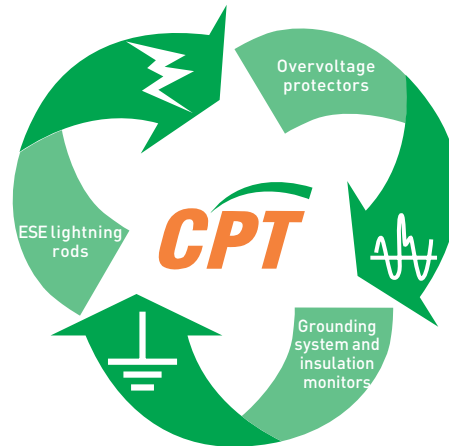

Type 2 pluggable protectors

Suitable for the second level of protection in supply distribution panels in which Type 1 protectors are installed, or for the first level of protection in residential, commercial or other applications not exposed to direct strikes and with no external lightning protection system.

- High discharge capacity tested with an 8/20 μ s waveform: 20 or 40 kA per phase.
- Suitable for residential and commercial applications (not provided with an external lightning protection system)
- Provides protection even for the most sensitive equipment (IEC 60634-4-443 Category 1)
- Local (visual) and remote (IR) end of life signalling.
- New optimised thermal disconnection system (both AC and DC).
- Wide range:
 - Exclusive devices for TNS, TNC and TT grounding arrangements for 120/208 V and 230/400 V supplies.
 - Solution using single-pole devices for IT systems or any supply voltage, up to 690 VAC.
 - Solution for photovoltaic applications, both solar field and rooftop, up to 1000 VDC. Common and differential mode protection. For both earthed and unearthed systems.
 - First solution in the market for PLC lines (Power Line Communication).
- Meets all current international standards (IEC 61643 / IEC 62305, etc.).



Wide range of solutions



Photovoltaic



Residential



PLC (power line communication)



Commercial

Type 1+2 pluggable protectors

Suitable for the first level of protection in incoming power supply panels and areas with greater exposure to the atmosphere, where installations are usually provided with external lightning protection systems.

- Devices capable of protecting all equipment from direct lightning strikes.
- Suitable for all types of application: residential, commercial or industrial.
- High discharge capacity 10/350 μ s: 12.5 kA or 25 kA per phase.
- Provides protection even for the most sensitive equipment (IEC 60634-4-443 Category 1)
- Local (visual) and remote (IR) end of life signalling.
- New optimised thermal disconnection system (both AC and DC).
- Wide range:
 - Exclusive devices for TNS, TNC or TT grounding arrangements for 120/208 V and 230/400 V supplies.
 - Solution for photovoltaic applications, both solar field and rooftop, up to 1000 VDC. Common and differential mode protection. For both earthed and unearthed systems.
- Meets all current international standards (IEC 61643 / IEC 62305, etc).



High discharge capacity 10/350 μ s



High value equipment



Aerogenerators



Industrial



For lightning currents



The best performance in the market

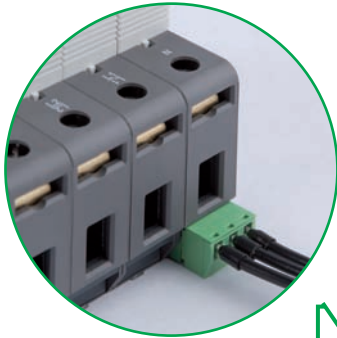

Remote indication



Dry contacts, optional in all ranges, for remote indication of protector end of life.

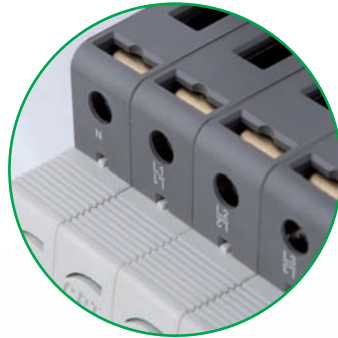

Biconnect connection

Two types of terminal: for rigid or flexible cable and for fork type comb busbar.



Cirprotec quality

Product range produced entirely by Cirprotec, with a thermal disconnection system. Use of the best materials and components.



Protector lifetime status indication

Clear display of protection end of life.

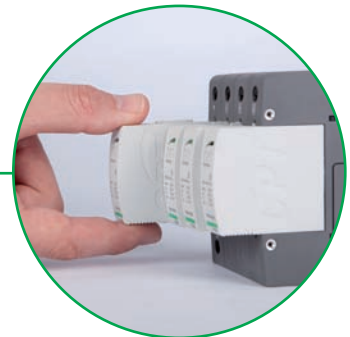

Easy to install

Easy and quick replacement of damaged cartridges.

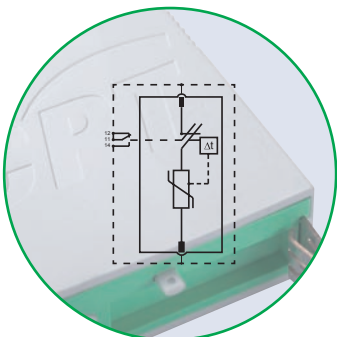

New, optimised disconnection system

Cirprotec has developed a new, optimised disconnection system for end of life. Complies with the disconnection tests of the new standard for protectors for photovoltaic applications.

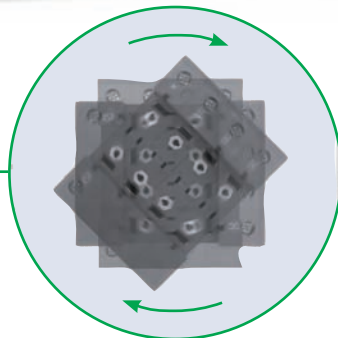

Reversible installation

Reversible chassis to allow cable entry from above or below.



Polariser

Safety system to avoid possible cartridge replacement errors.

Selection Guide

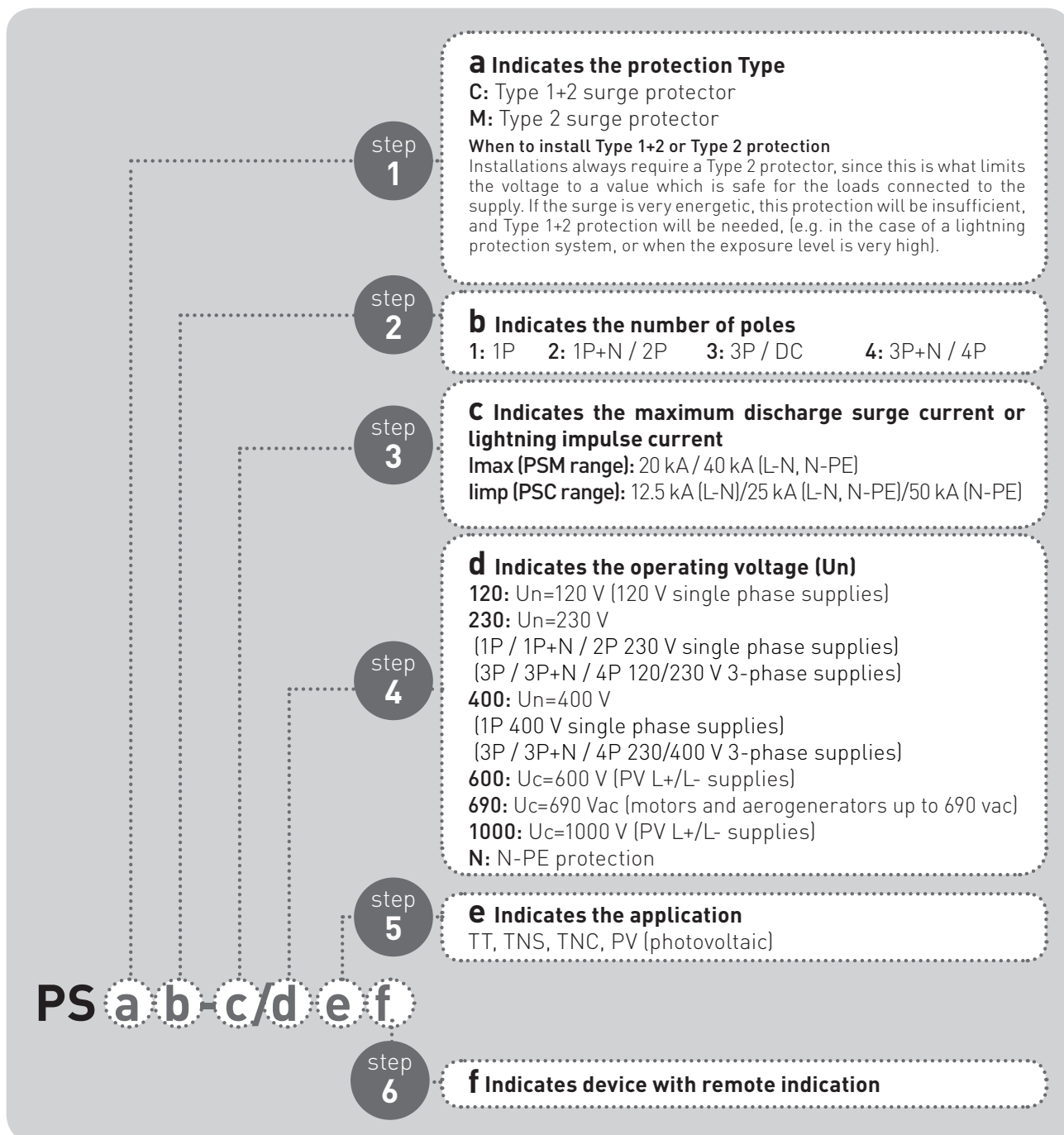

Example

> Protection for a 3-phase 230/400 V installation, with neutral mode TT, in a building with no external lightning protection.

Step 1: PSM or PSC. No external lightning protection. If the installation is not very subject to surges, Type 2 will be sufficient. Solution PSM a=M

Step 2: 3-phase installation, number of poles 4 b= 4

Step 3: Maximum discharge capacity. The standards do not specify this parameter, in fact the higher it is, the better the protection will be and the longer it will last. Solution: 40 kA c=40

Step 4: Un, for 3-phase supplies 230/400, Un=400 V d=400

Step 5: Indication of supply type (neutral mode), in this case supply TT e=TT

Step 6: Remote indication needed? It will depend on whether we have an alarm system; in this case we do, so f=IR

The Cirprotec part number would be: **PSM4-40/400 TT IR**



PSM range

Type 2 overvoltage protectors

	Code	Part number
	77707700	PSM1-20/120
	77707701	PSM1-20/120 IR
	77707702	PSM1-20/230
	77707703	PSM1-20/230 IR
	77707704	PSM1-20/400
	77707705	PSM1-20/400 IR
	77707706	PSM1-40/120
	77707707	PSM1-40/120 IR
	77707708	PSM1-40/230
	77707709	PSM1-40/230 IR
	77707710	PSM1-40/400
	77707711	PSM1-40/400 IR
	77707714	PSM1-40/690
	77707715	PSM1-40/690 IR
	77707745	PSM1-20N
77707746	PSM1-40N	
	77707750	PSM2-20/120 TT
	77707751	PSM2-20/120 TT IR
	77707752	PSM2-20/230 TT
	77707753	PSM2-20/230 TT IR
	77707754	PSM2-40/120 TT
	77707755	PSM2-40/120 TT IR
	77707756	PSM2-40/230 TT
	77707757	PSM2-40/230 TT IR
	77707900	PSM2-20/120 TNS
	77707901	PSM2-20/120 TNS IR
	77707902	PSM2-20/230 TNS
	77707903	PSM2-20/230 TNS IR
	77707904	PSM2-40/120 TNS
	77707905	PSM2-40/120 TNS IR
	77707906	PSM2-40/230 TNS
77707907	PSM2-40/230 TNS IR	
	77707860	PSM3-20/230 TNC
	77707861	PSM3-20/230 TNC IR
	77707862	PSM3-20/400 TNC
	77707863	PSM3-20/400 TNC IR
	77707864	PSM3-40/230 TNC
	77707865	PSM3-40/230 TNC IR
	77707866	PSM3-40/400 TNC
	77707867	PSM3-40/400 TNC IR
	77707850	PSM3-40/600 PV
	77707851	PSM3-40/600 PV IR
	77707852	PSM3-40/1000 PV
	77707853	PSM3-40/1000 PV IR
	77707800	PSM4-20/230 TT
	77707801	PSM4-20/230 TT IR
	77707802	PSM4-20/400 TT
77707803	PSM4-20/400 TT IR	
77707804	PSM4-40/230 TT	
77707805	PSM4-40/230 TT IR	
77707806	PSM4-40/400 TT	
77707807	PSM4-40/400 TT IR	
77707950	PSM4-20/230 TNS	
77707951	PSM4-20/230 TNS IR	
77707952	PSM4-20/400 TNS	
77707953	PSM4-20/400 TNS IR	
77707954	PSM4-40/230 TNS	
77707955	PSM4-40/230 TNS IR	
77707956	PSM4-40/400 TNS	
77707957	PSM4-40/400 TNS IR	

PSC range

Type 1+2 overvoltage protectors

	Code	Part number
	77738100	PSC1-12,5/120
	77738101	PSC1-12,5/120 IR
	77738105	PSC1-12,5/230
	77738106	PSC1-12,5/230 IR
	77738110	PSC1-12,5/400
	77738111	PSC1-12,5/400 IR
	77738180	PSC1-25N
	77738182	PSC1-50N
	77738120	PSC1-25/120
	77738121	PSC1-25/120 IR
	77738125	PSC1-25/230
	77738126	PSC1-25/230 IR
	77738130	PSC1-25/400
	77738131	PSC1-25/400 IR
	77738205	PSC2-12,5/230 TT
77738206	PSC2-12,5/230 TT IR	
77738200	PSC2-12,5/120 TT	
77738201	PSC2-12,5/120 TT IR	
77738255	PSC2-12,5/230 TNS	
77738256	PSC2-12,5/230 TNS IR	
77738250	PSC2-12,5/120 TNS	
77738251	PSC2-12,5/120 TNS IR	
77738320	PSC3-12,5/230 TNC	
77738321	PSC3-12,5/230 TNC IR	
77738325	PSC3-12,5/400 TNC	
77738326	PSC3-12,5/400 TNC IR	
77738370	PSC3-12,5/600 PV	
77738371	PSC3-12,5/600 PV IR	
77738375	PSC3-12,5/1000 PV	
77738376	PSC3-12,5/1000 PV IR	
77738405	PSC4-12,5/400 TT	
77738406	PSC4-12,5/400 TT IR	
77738400	PSC4-12,5/230 TT	
77738401	PSC4-12,5/230 TT IR	
77738455	PSC4-12,5/400 TNS	
77738456	PSC4-12,5/400 TNS IR	
77738450	PSC4-12,5/230 TNS	
77738451	PSC4-12,5/230 TNS IR	



Consult us for cartridge part numbers



www.cirprotec.com

Specialists in comprehensive lightning and surge protection solutions. Specific solutions for all types of applications.



Surge Protection



Permanent Overvoltage Protection



Surge Protection for Communications



External Lightning Protection



Monitoring of Grounding Systems



Insulation Monitoring



Beacon Systems



CIRPROTEC, S.L.
Lepanto 49 - 08223 Terrassa (BARCELONA) - SPAIN
Tel. +34 93 733 16 84 - Fax +34 93 733 21 64
comercial@cirprotec.com - export@cirprotec.com

Cirprotec Distributor / Representative: